

WF431ABP



Washing Machine

user manual

**Planet
First** 100%
Recycled Paper

This manual is made with 100% recycled paper.

imagine the possibilities

Thank you for purchasing this Samsung product.
To receive a more complete service, please
register your product at

www.samsung.com/register



features of your new VRT™ washer

- **VRT™ (Vibration Reduction Technology)**

This Samsung washer performs smoothly at top spin speeds, minimizing noise and vibration.

- **The Largest Capacity**

Samsung's extra-large capacity laundry machine can wash a full set of your bedding, a kingsize comforter, or up to 28 bath towels in a single load. Since you don't have to do as many loads, you save time, money, water and energy.

- **ecobubble**

Samsung's effective ecobubble delivers improved cleanliness with advanced fabric care. ecobubble PowerFoam allows detergent to disperse evenly and penetrate fabrics faster and deeper

- **Diamond drum™**

Take gentle care of your fabrics. With inside holes 36 % Smaller than those of conventional drums, the diamond drum prevents fabrics from sticking out and consequently being damaged.

- **Stylish design**

The stylish design of this washer blends well with your environment.

- **Digital display & Center jog dial**

The jog dial enables you to select cycles in both directions with ease, and the display is easy to use and understand.

- **DD Motor**

The power to handle anything! Our direct-drive inverter motor delivers power right to the washer tub from a variable speed, reversible motor. A beltless direct-drive motor generates a higher spin speed of 1,300 rpms for more effective, quiet operation. The washer also has fewer moving parts, meaning fewer repairs.

- **Sanitize**

When selecting this cycle, the water heats to an extra high temperature to remove 99.9 % of certain bacteria typically found on clothing, bedding, or towels. This certification is conducted by NSF International, an independent third-party testing and certification organization. Please check garment care label to avoid garment damage. Only sanitizing cycles have been designed to meet the requirements of this protocol for sanitization efficacy.

• **Eco Drum Clean**

Using Eco Drum Clean helps to maintain your washing machine with maximum hygiene. This feature has the option of using (or not using) drum cleaning chemical detergents, depending on your Eco/Performance preference – the cycle has been designed by Samsung to deliver results without chemical assistance. Keep your drum cleansed and odourless by using this specialised cleaning program which spins hot water (70 °C) in the drum, with the thorough cleansing cycle lasting for just under 90 minutes. This works to remove mould and bacteria present in the drum which could grow and lead to smells and discolouration if left alone.

Works perfectly in support of Eco Bubble, allowing you to routinely wash your fabrics in cooler temperatures and occasionally cleanse your wash drum to maintain top hygiene levels.

This manual contains important information on the installation, use, and care of your new Samsung washing machine. Refer to it for descriptions of the control panel, instructions on how to use the washing machine, and tips for making the most of its state-of-the-art features and functions. The “Troubleshooting and information codes” section on page 34 tells you what to do if something goes wrong with your new washing machine.

safety information

Congratulations on your new Samsung washer. This manual contains important information on the installation, use and care of your appliance. Please take time to read this manual to take full advantage of your washer's many benefits and features.











WHAT YOU NEED TO KNOW ABOUT SAFETY INSTRUCTIONS

Please read this manual thoroughly to ensure that you know how to safely and efficiently operate the extensive features and functions of your new appliance and retain it at a safe place near the appliance for your future reference. Use this appliance only for its intended purpose as described in this instruction manual. Warnings and Important Safety Instructions in this manual do not cover all possible conditions and situations that may occur. It is your responsibility to use common sense, caution, and care when installing, maintaining, and operating your washer.

Because these following operating instructions cover various models, the characteristics of your washer may differ slightly from those described in this manual and not all warning signs may be applicable. If you have any questions or concerns, contact your nearest service center or find help and information online at www.samsung.com.

IMPORTANT SAFETY SYMBOLS AND PRECAUTIONS

What the icons and signs in this user manual mean:

 WARNING	Hazards or unsafe practices that may result in severe personal injury, death and/or property damage.
 CAUTION	Hazards or unsafe practices that may result in personal injury and/or property damage.
 CAUTION	To reduce the risk of fire, explosion, electric shock, or personal injury when using your washer, follow these basic safety precautions:
	Do NOT attempt.
	Do NOT disassemble.
	Do NOT touch.
	Follow directions explicitly.
	Unplug the power plug from the wall socket.
	Make sure the machine is grounded to prevent electric shock.
	Call the service centre for help.
	Note

These warning signs are here to prevent injury to you and others.

Please follow them explicitly.

After reading this section, keep it in a safe place for future reference.

 Read all instructions before using the appliance.

As with any equipment using electricity and moving parts, potential hazards exist. To safely operate this appliance, become familiar with its operation and exercise care when using it.



Do not let children (or pets) play on or in your washing machine. The washing machine door does not open easily from the inside, and children may be seriously injured if trapped inside.



This appliance is not intended for use by persons (including children) with reduced physical, sensory or mental capabilities, or lack of experience and knowledge, unless they have been given supervision or instruction concerning use of the appliance by a person responsible for their safety.

Children should be supervised to ensure that they do not play with the appliance.

If the plug (power supply cord) is damaged, it must be replaced by the manufacturer or its service agent or a similarly qualified person in order to avoid a hazard.

This appliance should be positioned to be accessible to the power plug, the water supply tabs and the drain pipes.

For washing machines with ventilation openings in the base, ensure that the opening is not obstructed by carpet or any other obstacles.

Use the new hose-sets and old hose-sets should not be reused.

INSTRUCTION ABOUT THE WEEE MARK



Correct Disposal of This Product (Waste Electrical & Electronic Equipment)

(Applicable in the European Union and other European countries with separate collection systems)

This marking on the product, accessories or literature indicates that the product and its electronic accessories (e.g. charger, headset, USB cable) should not be disposed of with other household waste at the end of their working life. To prevent possible harm to the environment or human health from uncontrolled waste disposal, please separate these items from other types of waste and recycle them responsibly to promote the sustainable reuse of material resources.

Household users should contact either the retailer where they purchased this product, or their local government office, for details of where and how they can take these items for environmentally safe recycling.

Business users should contact their supplier and check the terms and conditions of the purchase contract. This product and its electronic accessories should not be mixed with other commercial wastes for disposal.

safety information



WARNING

SEVERE WARNING SIGNS FOR INSTALLATION

- ★ The installation of this appliance must be performed by a qualified technician or service company.

- Failure to do so may result in electric shock, fire, an explosion, problems with the product, or injury.

The appliance is heavy, take care upon lifting it

Plug the power cord into an 220-240 V / 50 Hz wall socket or higher and use the socket for this appliance only. In addition, do not use an extension cord.

- Sharing a wall socket with other appliances using a power strip or extending the power cord may result in electric shock or fire.
- Ensure that the power voltage, frequency and current are the same as those of the product specifications. Failure to do so may result in electric shock or fire. Plug the power plug into the wall socket firmly.

Remove all foreign substances such as dust or water from the power plug terminals and contact points using a dry cloth on a regular basis.

- Unplug the power plug and clean it with a dry cloth.
- Failure to do so may result in electric shock or fire.

Plug the power plug into the wall socket in the right direction so that the cord runs towards the floor.

- If you plug the power plug into the socket in the opposite direction, the electric wires within the cable may be damaged and this may result in electric shock or fire.

Keep all packaging materials well out of the reach of children, as packaging materials can be dangerous to children.

- If a child places a bag over its head, it may result in suffocation.

When the appliance or power plug or power cord is damaged, contact your nearest service centre.



- This appliance must be properly grounded.

Do not ground the appliance to a gas pipe, plastic water pipe, or telephone line.

- This may result in electric shock, fire, an explosion, or problems with the product
- Never plug the power cord into a socket that is not grounded correctly and make sure that it is in accordance with local and national codes.



- Do not install this appliance near a heater, inflammable material.

Do not install this appliance in a humid, oily or dusty location, in a location exposed to direct sunlight and water (rain drops).

Do not install this appliance in a location of Low Temperature

- Frost may cause tubes to burst

Do not install this appliance in a location where gas may leak.

- This may result in electric shock or fire.

Do not use an electric transformer.

- It may result in electric shock or fire.

Do not use a damaged power plug, damaged power cord or loose wall socket.

- This may result in electric shock or fire.

Do not pull or excessively bend the power cord.

Do not twist or tie the power cord.

6_ safety information



Do not hook the power cord over a metal object, place a heavy object on the power cord, insert the power cord between objects, or push the power cord into the space behind the appliance.

- This may result in electric shock or fire.

Do not pull the power cord, when unplugging the power plug.

- Unplug the power plug by holding the plug.
- Failure to do so may result in electric shock or fire.

Do not lay the power cord and tubes where you may fall over them.



CAUTION SIGNS FOR INSTALLATION



- This appliance should be positioned in such a way that it is accessible to the power plug.
 - Failure to do so may result in electric shock or fire due to electric leakage.

Install your appliance on a level and hard floor that can support its weight.

- Failure to do so may result in abnormal vibrations, moves, noise, or problems with the product.



SEVERE WARNING SIGNS FOR USING



- If the appliance is flooded, Turn off the water & power supply immediately and contact your nearest service centre.

- Do not Touch the power plug with wet hands
- Failure to do so may cause electric shock

If the appliance generates a strange noise, a burning smell or smoke, unplug the power plug immediately and contact your nearest service centre.

- Failure to do so may result in electric shock or fire.

In the event of a gas leak (such as propane gas, LP gas, etc.), ventilate immediately without touching the power plug. Do not touch the appliance or power cord.

- Do not use a ventilating fan.
- A spark may result in an explosion or fire.

Do not let children play in or on the washer. In addition, when disposing of the appliance, remove the washer door lever.

- If trapped inside, the child may become trapped and suffocate to death.

Make sure to remove the packaging (sponge, styrofoam) attached to the bottom of the washer before using it.



safety information

 Do not wash items contaminated with gasoline, kerosene, benzene, paint thinner, alcohol or other flammable or explosive substances.

- This may result in electric shock, fire or an explosion.

Do not open the washer door by force while it is operating (high-temperature washing/drying/spinning).

- Water flowing out of the washer may result in burns or cause the floor to be slippery.

This may result in injury.

- Opening the door by force may result in damage to the product or injury.

Do not insert your hand under the washer.

- This may result in injury.

Do not touch the power plug with wet hands.

- This may result in electric shock.

Do not turn the appliance off by unplugging the power plug while an operation is in progress.

- Plugging the power plug into the wall socket again may cause a spark and result in electric shock or fire.

Do not let children or infirm persons use this washer unsupervised. Do not let children climb in the appliance

- Failure to do so may result in electric shock, burns or injury.

Do not insert your hand or a metal object under the washer while it is operating.

- This may result in injury.

Do not unplug the appliance by pulling at the power cord, always grip plug firmly and pull straight out from the outlet.

- Damage to the cord may cause short-circuit, fire and/or electric shock

 Do not attempt to repair, disassemble, or modify the appliance yourself.

- Do not use any fuse (such as copper, steel wire, etc.) other than the standard fuse.
- When repairing or reinstalling the appliance is required, contact your nearest service centre.
- Failure to do so may result in electric shock, fire, problems with the product, or injury.

 If the water supply hose comes loose from the Water tap and floods the appliance, unplug the power plug.

- Failure to do so may result in electric shock or fire.

Unplug the power plug when the appliance is not being used for long periods of time or during a thunder/lightning storm.

- Failure to do so may result in electric shock or fire.



CAUTION SIGNS FOR USING



When the washer is contaminated by a foreign substance such as detergent, dirt, food waste, etc., unplug the power plug and clean the washer using a damp and soft cloth.

- Failure to do so may result in discolouration, deformation, damage or rust.

The front glass may be broken by a strong impact. Take care when using the washer.

- When the glass is broken, it may result in injury.

After a water supply failure or when reconnecting the water supply hose, open the Water Tap slowly.

Open the Water Tap slowly after a long period of non-use.

- The air pressure in the water supply hose or the water pipe may result in damage to a part or in water leakage.

If a drain error occurs during an operation, check if there is a draining problem.

- If the washer is used when it is flooded because of a draining problem, it may result in electric shock or fire due to electric leakage.

Insert the laundry into the washer completely so that laundry does not get caught in the door.

- If laundry gets caught in the door, it may result in damage to the laundry or the washer, or result in water leakage.

Ensure that the Water Tap is turned off when the washer is not being used.

- Ensure that the screw on the water supply hose connector is properly tightened.
- Failure to do so may result in property damage or injury.

Take care that the rubber seal and the front door glass are not contaminated by a foreign substance (e.g. waste, thread, hair, etc.)

- If a foreign substance is caught in the door or the door is not completely closed, it may cause a water leakage.

Open the Water Tap and check if the water supply hose connector is firmly tightened and that there is no water leaking before using the product.

- If the screws or the water supply hose connector are loose, it may result in water leakage.

safety information

- ☐ Do not stand on top of the appliance or place objects (such as laundry, lighted candles, lighted cigarettes, dishes, chemicals, metal objects, etc.) on the appliance.
 - This may result in electric shock, fire, problems with the product, or injury.
- Do not spray volatile material such as insecticide onto the surface of the appliance.
 - As well as being harmful to humans, it may also result in electric shock, fire or problems with the product.
- Do not place an object that generates a electromagnetic field near the washer.
 - This may result in injury due to a malfunction.
- Since the water drained during a high-temperature wash or drying cycle is hot, do not touch the water.
 - This may result in burns or injury.
- Do not wash, spin or dry water-proof seats, mats or clothing (*) unless your appliance has a special program for washing these items.
 - Do not wash thick, hard mats even if the washer mark is on the care label.
 - This may result in injury or damage to the washer, walls, floor or clothing due to abnormal vibrations.
- * Woollen bedding, rain covers, fishing vests, ski pants, sleeping bags, diaper covers, sweat suits, and bicycle, motor cycle, car covers, etc.
- Do not operate the washer when the detergent box is removed.
 - This may result in electric shock or injury due to water leakage.
- Do not touch the inside of the tub during or just after drying as it is hot.
 - This may result in burns.
- Do not insert your hand into the detergent box after opening it.
 - This may result in injury as your hand may be caught by the detergent input device. Do not place any objects (such as shoes, food waste, animals) other than laundry into the washer.
 - This may result in damage to the washer, or injury and death in the case of pets due to the abnormal vibrations.
- Do not press the buttons using sharp objects such as pins, knives, fingernails, etc.
 - This may result in electric shock or injury.
- Do not wash laundry contaminated by oils, creams or lotions usually found in skincare shops or massage clinics.
 - This may result in the rubber seal becoming deformed and water leakage.
- Do not leave metal objects such as a safety pin or hair pin, or bleach in the tub for long periods of time.
 - This may cause the tub to rust.
 - If rust starts appearing on the surface of the tub, apply a cleansing agent (neutral) to the surface and use a sponge to clean it. Never use a metal brush.
- Do not use dry cleaning detergent directly and do not wash, rinse, or spin laundry contaminated by dry cleaning detergent.
 - This may result in spontaneous combustion or ignition due to the heat of the oxidation of the oil.
- Do not use hot water from water cooling/heating devices.
 - This may result in problems with the washer.



Do not use natural hand-washing soap for the washer.

- If it hardens and accumulates inside the washer, it may result in problems with the product, discolouration, rust or bad odors.

Do not wash large laundry items such as bedding in the washing net.

- Place socks and brassieres into the washing net and wash them with the other laundry.
- Failure to do so may result in injury due to abnormal vibrations.

Do not use hardened detergent.

- If it accumulates inside the washer, it may result in water leakage.

For washing machines with ventilation openings in the base, ensure that the opening is not obstructed by carpet or any other obstacles.

Make sure that the pockets of all clothing to be washed are empty.

- Hard, sharp objects, such as coins, safety pins, nails, screws, or stones can cause extensive damage to the appliance.

Do not wash clothing with large buckles, buttons, or other heavy metal.

The tumble dryer is not to be used if industrial chemicals have been used for cleaning.

Lint must not be allowed to accumulate around the tumble dryer.

Do Not Dry Unwashed Items In The Tumble Dryer.

Items that have been soiled with substances such as cooking oil, acetone, alcohol, petrol, kerosene, spot removers, turpentine, waxes and wax removers should be washed in hot water with an extra amount of detergent before being dried in the tumble dryer.

Items such as foam rubber (latex foam), shower caps, waterproof textiles, rubber backed articles and clothes or pillows fitted with foam rubber pads should not be dried in the tumble dryer.

Fabric softeners, or similar products, should be used as specified by the fabric softener instructions.

The final part of a tumble dryer cycle occurs without heat (cool down cycle) to ensure that the items are left at a temperature that ensures that the items will not be damaged.

WARNING: Never stop a tumble dryer before the end of the drying cycle unless all items are quickly removed and spread out so that the heat is dissipated.

That the appliance must not be installed behind a lockable door, a sliding door or a door with a hinge on the opposite side to that of the tumble dryer.



SEVERE WARNING SIGNS FOR CLEANING



- Do not clean the appliance by spraying water directly onto it.
- Do not use benzene, thinner or alcohol to clean the appliance.
- This may result in discolouration, deformation, damage, electric shock or fire.

Before cleaning or performing maintenance, unplug the appliance from the wall socket.

- Failure to do so may result in electric shock or fire.



contents

SETTING UP YOUR WASHING MACHINE

13

- 13 Checking the parts
- 14 Meeting installation requirements
- 14 Electrical supply and grounding
- 14 Water Supply
- 15 Drain
- 15 Flooring
- 15 Surrounding temperature
- 15 Alcove or closet Installation
- 15 Installing your washing machine

WASHING A LOAD OF LAUNDRY

21

- 21 Washing for the first time
- 21 Basic instructions
- 22 Using the control panel
- 24 Child lock
- 24 Interior Lamp
- 24 Delay end
- 25 My cycle
- 26 Eco Bubble
- 27 Washing clothes using the cycle selector
- 28 Washing clothes manually
- 28 Laundry guidelines
- 30 Detergent and additives information
- 30 Which detergent to use
- 30 Detergent drawer

CLEANING AND MAINTAINING YOUR WASHING MACHINE

31

- 31 Cleaning the exterior
- 31 Cleaning the interior
- 31 Cleaning the dispensers
- 32 Storing your washer
- 32 Cleaning the debris filter
- 33 Cleaning the door seal/bellow
- 33 Cleaning the door glass
- 33 Preserving the top cover and the front frame

TROUBLESHOOTING AND INFORMATION CODES

34

- 34 Check these points if your washing machine...
- 36 Information codes

CYCLE CHART

37

- 37 Cycle chart

APPENDIX

38

- 38 Fabric care chart
- 38 Protecting the environment
- 38 Declaration of conformity
- 39 Sheet of household washing machines

setting up your washing machine

Be sure to have your installer follow these instructions closely so that your new washing machine works properly and so that you're not at risk of injury when doing laundry.

CHECKING THE PARTS

Carefully unpack your washing machine, and make sure you've received all of the parts shown below. If your washing machine was damaged during shipping, or if you do not have all of the parts, contact Samsung Customer Service or your Samsung dealer.

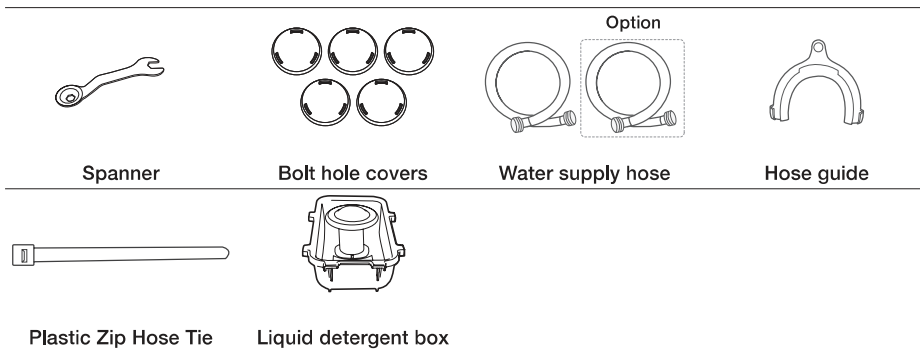
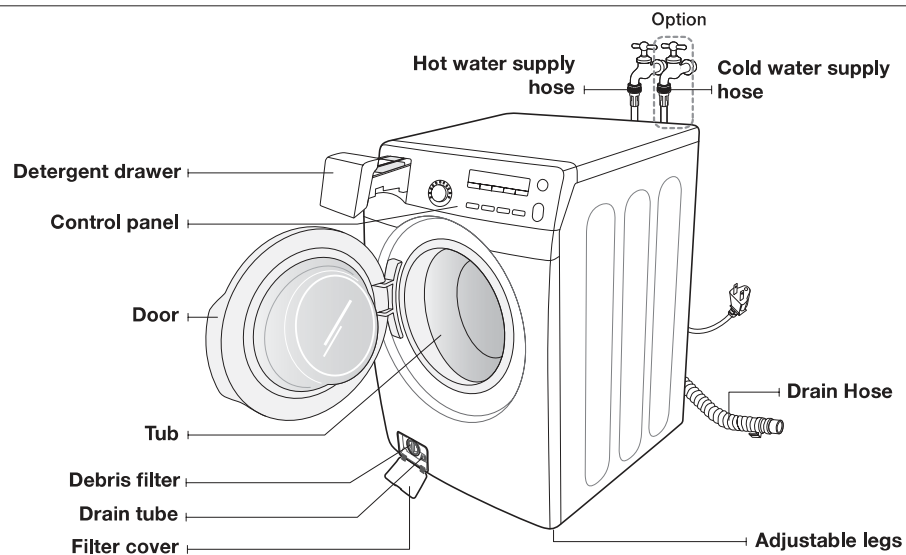

setting up your washing machine

MEETING INSTALLATION REQUIREMENTS

Electrical supply and grounding

 Never use an extension cord.
WARNING Use only the power cord that comes with your washing machine.

When preparing for installation, ensure that your power supply offers:

- 220-240 V / 50 Hz fuse or circuit breaker
- Individual branch circuit serving only your washing machine

Your washing machine must be grounded. If your washing machine malfunctions or breaks down, grounding will reduce the risk of electric shock by providing a path of least resistance for the electric current.

Your washing machine comes with a power cord having a three-prong grounding plug for use in a properly installed and grounded outlet.

 Never connect the ground wire to plastic plumbing lines, gas lines, or hot water pipes.

Improperly connecting the equipment-grounding conductor can result in electric shock. Check with a qualified electrician or serviceman if you are unsure if the washing machine is properly grounded. Do not modify the plug provided with the washing machine. If it does not fit the outlet, have a proper outlet installed by a qualified electrician.

Water Supply

Your washing machine will fill properly when your water pressure is 137 kPa ~ 800 kPa. Water pressure less than 137 kPa may cause water valve failure, not allowing the water valve to shut off completely. Or, it may take the washing machine longer to fill than what the controls allow, resulting in your washing machine turning off. (A fill-time limit, designed to prevent overflows/flooding if an internal hose becomes loose, is built into the controls.)

The water taps must be within 120 cm of the back of your washing machine for the provided inlet hoses provided to reach your washing machine.

 Most plumbing supply stores sell inlet hoses of various lengths up to 305 cm long.

You can reduce the risk of leaks and water damage by:

- Making water taps easily accessible.
- Turning off taps when the washing machine is not in use.
- Periodically checking for leaks at water inlet hose fittings.

 Before using your washing machine for the first time, check all connections at the water valve and taps for leaks.
WARNING

 An 'Approved' single check valve or some other no less effective backflow prevention device shall be fitted at the point of connection(s) between the supply and the fitting.



Drain

Samsung recommends a standpipe height of 46cm. The drain hose must be routed through the drain hose clip to the standpipe. The standpipe must be large enough to accept the outside diameter of the drain hose. The drain hose is attached at the factory.

Flooring

For best performance, your washing machine must be installed on a solidly constructed floor. Wood floors may need to be reinforced to minimize vibration and/or unbalanced loads. Carpeting and soft tile surfaces are contributing factors to vibrations and the tendency for your washing machine to move slightly during the spin cycle.

Never install your washing machine on a platform or poorly supported structure.

Surrounding temperature

Do not install your washing machine in areas where water may freeze, since your washing machine always retains some water in its water valve, pump, and hose areas. Frozen water in the lines can cause damage to belts, the pump, and other components.

Alcove or closet installation

To operate safely and properly, your new washing machine requires minimum clearances of:

Sides – 25 mm	Rear – 102 mm
Top – 432 mm	Front – 51 mm

If both the washing machine and a dryer are installed together, the front of the alcove or closet must have at least 465 cm² unobstructed air opening. Your washing machine alone does not require a specific air opening.

INSTALLING YOUR WASHING MACHINE

STEP 1

Selecting a location



Before you install the washing machine, make sure the location:

- Has a hard, level surface without carpeting or flooring that may obstruct ventilation
- Is away from direct sunlight
- Has adequate ventilation
- Will not be freezing (below 0 °C)
- Is away from heat sources such as oil or gas
- Has enough space so that the washing machine doesn't stand on its power cord

setting up your washing machine

STEP 2

Removing the shipping bolts

Before installing the washing machine, you must remove all shipping bolts from the back of the unit.

1. Loosen all the bolts with the supplied wrench.

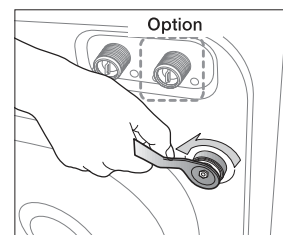

2. Hold the bolt with the spanner and pull it through the wide section of the hole. Repeat for each bolt.

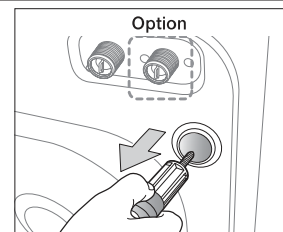

3. Fill the holes with the supplied plastic covers.

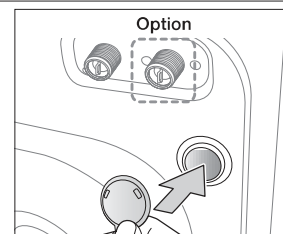

4. Store the shipping bolts away safely in case you have to move the washing machine in the future.

 Packaging materials can be dangerous to children; keep all packaging material (plastic bags, polystyrene, etc.) well out of the reach of children.

STEP 3 Adjusting the Levelling feet

 When installing your washing machine, ensure that the power plug, the water supply and the drain are easily accessible.

1. Slide the washing machine into position.
2. Level your washing machine by turning the levelling feet in and out as necessary by hand.

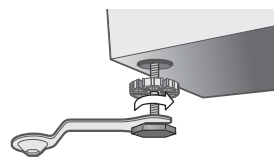

3. When your washing machine is level, tighten the nuts using the wrench supplied with your washing machine.

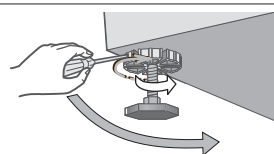

STEP 4 Connecting the water and drain

Connecting the water supply hose

1. Take the L-shaped arm fitting for the cold water supply hose and connect it to the cold water supply intake on the back of the machine. Tighten by hand.
-  The water supply hose must be connected to the washing machine at one end and to the water tap at the other. Do not stretch the water supply hose. If the hose is too short, replace the hose with a longer, high pressure hose.
2. Connect the other end of the cold water supply hose to your sink's cold water tap and tighten it by hand. If necessary, you can reposition the water supply hose at the washing machine end by loosening the fitting, rotating the hose, and retightening the fitting.

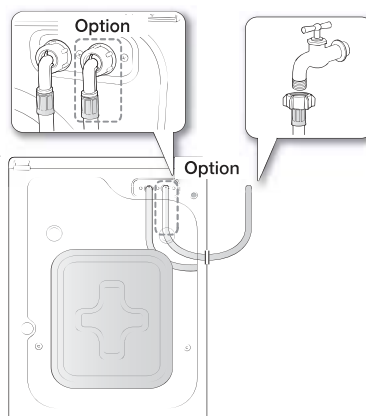

For selected models with an additional hot water intake:

1. Take the red L-shaped arm fitting for the hot water supply hose and connect it to the hot water supply intake on the back of the machine. Tighten by hand.
2. Connect the other end of the hot water supply hose to your sink's hot water tap and tighten it by hand.
3. Use a Y-piece if you only want to use cold water.

setting up your washing machine

Connecting the water supply hose

1. Remove the adaptor from the water supply hose.

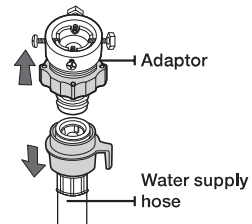

2. First, using a '+' type screwdriver, loosen the four screws on the adaptor. Next, take the adaptor and turn part (2) following the arrow until there is a 5 mm gap.

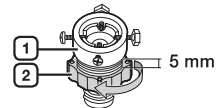

3. Connect the adaptor to the water tap by tightening the screws firmly while lifting the adaptor upwards. Turn part (2) following the arrow and connect (1) and (2).

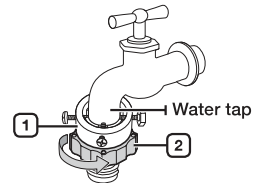

4. Connect the water supply hose to the adaptor. When you release part (3), the hose automatically connects to the adaptor making a 'click' sound.

-  After you have connected the water supply hose to the adaptor, ensure that it is connected correctly by pulling the water supply hose downwards.

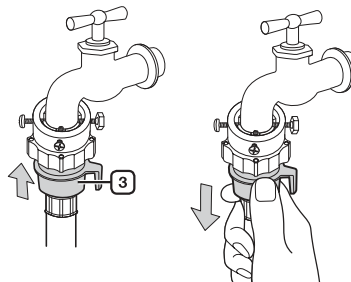

5. Connect the other end of the water supply hose to the inlet water valve at the rear of the washing machine. Screw the hose clockwise all the way in.

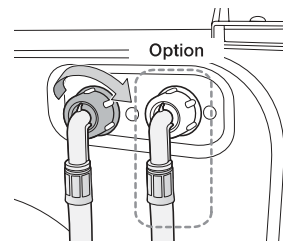



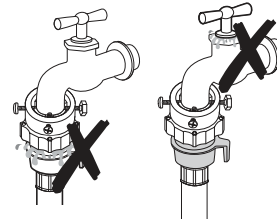

6. Turn on the water supply and ensure that no water leaks from the water valve, tap or adaptor. If there is a water leaks, repeat the previous steps.

 **WARNING** Do not use your washing machine if there is a water leak. This may cause electric shock or injury.

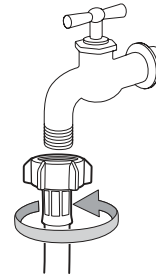

- If the water tap has a screw type tap, connect the water supply hose to the tap as shown.



-  Use the most conventional type of tap for the water supply. In case the tap is square or too big, remove the spacing ring before inserting the tap into the adaptor.

- Water pipe must be protected with an appropriate "Family E" device (single check valve) at the point of connection of the hose to the supplying pipework. An 'Approved' single check valve or some other no less effective backflow prevention device shall be fitted at the point of connection(s) between the supply and the fitting. Usage of materials that meet EU legislation for electrics, and WRAS approval for the check valve is highly recommended. If an installer chooses not to follow our instructions then the warranty may become invalid.

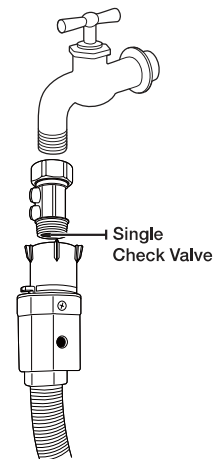

setting up your washing machine

Connecting the drain hose

The end of the drain hose can be positioned in three ways:

1. **Over the edge of a wash basin:** The drain hose must be placed at a height of between 60 and 90 cm. To keep the drain hose spout bent, use the supplied plastic hose guide. Secure the guide to the wall with a hook or to the tap with a piece of string to prevent the drain hose from moving.

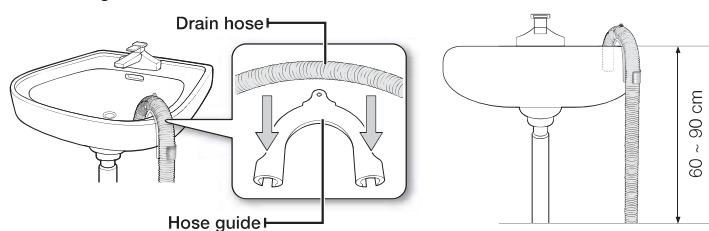

2. **In a sink drain pipe branch:** The drain pipe branch must be above the sink siphon so that the end of the hose is at least 60 cm above the ground.
3. **In a drain pipe:** We recommend using a 65 cm high vertical pipe; it must be no shorter than 60 cm and no longer than 90 cm.

STEP 5

Powering your washing machine

Plug the power cord into a wall sockets, an 220-240 V / 50 Hz approved electrical outlet protected by a fuse or circuit breaker. (For more information on electrical and grounding requirements, see page 14.)

STEP 6

Calibration Mode

Run calibration mode, when the washing machine is installed for the first time (or you want to calibrate it).

1. Remove laundry or any contents in the machine and turn off the machine.
2. When you press and hold on the "Temp" and "Delay End" button, press the "Power" button.
3. If the machine turns on, press the "Start" button. The calibration mode starts.
4. The drum spins right and left side on several times. (The calibration mode will take about minutes.)
5. When the calibration finish, "END" message displays.
6. If the door is unlocked, the machine turn off automatically.

washing a load of laundry

With your new Samsung washing machine, the hardest part of doing laundry will be deciding which load to wash first.

WASHING FOR THE FIRST TIME

 Before washing laundry for the first time, you must run a complete empty cycle (i.e. no laundry).

1. Press the **Power** button.
2. Add a little detergent to the detergent compartment ① in the detergent drawer.
3. Turn on the water supply to the washing machine.
4. Press the **Start/Pause** button.

 This will remove any water that might be left over in the machine from the manufacturer's test run.

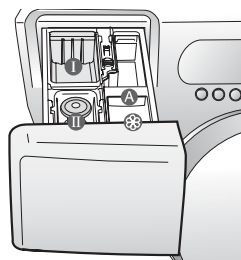

Compartment ①: Detergent for prewash, or starch.

Compartment ②: Detergent for the main wash, water softener, pre-soaking agent, bleach and stain removal product.

 To use liquid detergent, use the liquid detergent box (refer to page 30 of the manual for the corresponding model). Do not add powdered detergent into the liquid detergent box.

Compartment ③: Additives, e.g. fabric softener or former (fill no higher than lower edge (MAX) of "A")

BASIC INSTRUCTIONS

1. Load your laundry into the washing machine.

 **WARNING** Do not overload the washing machine. To determine the load capacity for each type of laundry, refer to the chart on page 28-29.

-  • Make sure that laundry is not caught in the door, as this may cause a water leak.
- Washing detergent may remain in the front rubber part of the washer after a wash cycle. Remove any remaining detergent, as they may cause a water leak.
- Do not touch the door glass while your washing machine is running or it may be hot.
 - Do not open the detergent drawer or the debris filter while your washing machine is running or you might be exposed to hot water or steam.
 - Do not wash water-proofed items in normal cycle except outdoor care program.

2. Close the door until it latches.
3. Turn the power on.
4. Add detergent and additives to the dispenser drawer.
5. Select the appropriate cycle and options for the load.
The Wash Indicator light will illuminate and the estimated cycle time will appear in the display.
6. Press the **Start/Pause** button.

washing a load of laundry

USING THE CONTROL PANEL

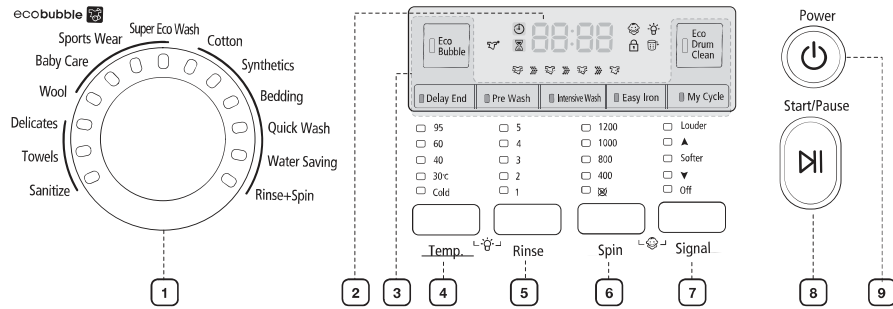

1 CYCLE SELECTOR

Select the tumble pattern and spin speed for the cycle.



For detailed information, refer to "Washing clothes using the cycle selector", (see page 27)

Cotton - For average or lightly soiled cottons, bed linen, table linen, underwear, towels, shirts, etc.

Synthetics - For averagely or lightly soiled blouses, shirts, etc., made of polyester (diolen, trevira), polyamide (perlon, nylon) or other similar blends.

Bedding - For bulky items such as blankets and sheets. When you are washing comforters, use liquid detergent.

Quick Wash - For lightly soiled garments needed quickly.

Water Saving - This is a specially designed course that enables you to wash laundry effectively with the minimum amount of water.

Rinse + Spin - Use for a load that needs rinsing only or to add rinse-added fabric softener to a load.

Super Eco Wash - Low Temperature Eco Bubble ensures that you achieve perfect wash results while allowing effective energy saving.

Sports Wear - Use for outdoor wear such as mountain clothes, skiwear, and sports wear. Fabrics include functional technology finishes and fibers such as spandex, stretch, and micro-fiber.

Baby Care - High temperature wash and extra rinses ensure that no washing powder remains to mark your thin clothes.

Wool - This is the course for lingerie or clothing made from wool. For machine-washable wool.

- The wool course washes the laundry using gentle cradling actions. During the wash, the gentle cradling and soaking actions are continued to protect the wool fibers from shrinkage / distortion and for a super gentle clean. This stop operation is not a problem.
- Neutral detergent is recommended for wool course, for improved washing results and for improved care of the wool fibers.

Delicates - For sheer fabrics, bras, lingerie silk, and other handwash-only fabrics. For best results, use liquid detergent.

Towels - For bath towels, washcloths and mats.

Sanitize - For heavily soiled, colorfast garments. This cycle heats the water to 65 °C (150 °F) to eliminate bacteria.



If you select pause during the heating portion of the Sanitize Cycle, your Washer door will remain locked for your safety.

2	DIGITAL DISPLAY	The large DIGITAL Display is easy to use. It provides instructions and diagnostics while keeping you updated on the cycle status and time remaining.
3	SELECT CYCLE OPTION	<p>Eco Bubble - Eco Bubble selection is turned on as a default. Press the Eco Bubble option button once to deselect and the Bubble Generator OFF (shown on the panel), press it again to turn the function back ON.</p> <ul style="list-style-type: none"> Some wash cycles must have Eco Bubble option ON (will show on the panel, and the Generator will turn on automatically). Other wash cycles do not need this option and automatically turn the Generator OFF. On many cycles, you can manually adjust this option, which will visibly affect wash time on the panel to achieve results (please see page 26 for more information). <p>Delay End - Any cycle can be delayed for up to 24 hours in one-hour increments. Displayed hour indicates the time at which the wash will be finished.</p> <p>Pre Wash - To use this feature add detergent to the Pre Wash section of the detergent compartment. When turned on, the washer fills with cold water and detergent, tumbles, then drains and advances to the selected wash cycle.</p> <p>Some cycles cannot be selected with this option.* * You cannot select the PreWash option in the, Wool and Quick Wash cycles.</p> <p>Intensive Wash - Press this button when the laundry is heavily soiled and needs to be washed intensively. The cycle time will be increased if the intensive wash is on.</p> <p>Easy Iron - Press this button to prepare your laundry so that it can be easily ironed by reducing the wrinkles during the spin cycle.</p> <ul style="list-style-type: none"> Easy Iron is only available for the following wash programs: Cotton, Synthetics, Sports wear, Baby care When Easy Iron is selected, you can set the spin cycle speed up to 800 rpm. (If you select Easy Iron with a spin cycle speed set to higher than 800 rpm, the spinning speed is automatically changed to 800 rpm.) <p>My Cycle - Choose your favorite cycle including temperature, spin, soil level, option, etc.</p> <p>Eco Drum Clean - Use for drum cleaning. It cleanses dirt and bacteria of drum. Regular use (after every 40 washes) is recommended. No detergent or bleach needed.</p>
4	TEMPERATURE SELECTION BUTTON	Press this button repeatedly to cycle through the available water temperature options: (Cold Water , 30 °C, 40 °C, 60 °C and 95 °C).
5	RINSE SELECTION BUTTON	Press this button to add additional rinse cycles. The maximum number of rinse cycles is five.
6	SPIN SELECTION BUTTON	Press the button repeatedly to cycle through the available speeds for the spin cycle.
7	SIGNAL SELECTION BUTTON	"No spin  - The laundry remains in the drum and no spin cycle is performed after the final drain.
8	SIGNAL SELECTION BUTTON	Press the button to select the signal level. (Louder → ▲ → Softer → ▼ → Off)
9	START/PAUSE SELECTION BUTTON	Press to pause and restart programs.
9	POWER BUTTON	Press once to turn your washer on, press again to turn your washer off. If the washer is left on for more than 10 minutes without any buttons being touched, the power automatically turns off.

washing a load of laundry

Child lock

The Child Lock function allows you to lock the buttons so that the wash cycle you've chosen can't be changed.

Activating/Deactivating

If you want to activate or deactivate the Child Lock function, press the **Spin** and **Signal** buttons at the same time for 3 seconds. "Child Lock" will be lit when this feature is activated.

- When the Child Lock function is activated, only the **Power** button works. The Child Lock function remains on even after the power is turned on and off or after the disconnecting and reconnecting the power cord.

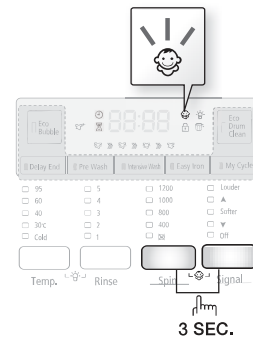

Interior Lamp

- If the door is opened when the power is on, the Interior Lamp is automatically turned on.
- If the door is closed when the power is on, the Interior Lamp is automatically turned off.
- Press the **Temp.** and the **Rinse** buttons simultaneously when the power is on to turn the Interior Lamp on or off.
- If 5 minutes have passed after the Interior Lamp is turned on, the Interior Lamp is automatically turned off.

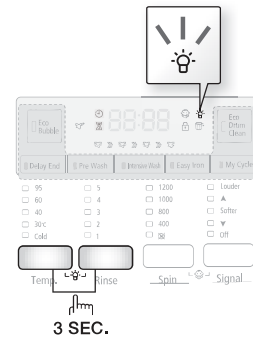

Delay end

You can set the washing machine to finish your wash automatically at a later time, choosing a delay of max 24 hours (in 1 hour increments). The hour displayed indicates the time at which the wash will be finished



- Manually or automatically set your washing machine according to the type of laundry you are washing.
- Press the **Delay End** button repeatedly until the delay time is set.
- Press the **Start/Pause** button. The "Delay End" indicator will be lit, and the clock will begin counting down until it reaches the set time.
- To cancel a Delay End function, press the **Power** button and then turn the washing machine on again.

My cycle

Allows you to activate your custom wash (temperature, spin, soil level, etc.) with one button convenience.

By pushing the **My Cycle** button, press the My Cycle button to load and use the saved My Cycle options. The chosen course and option lights will flicker.

You can set all options as follows in the My Cycle mode.

1. Turn the water supply on.
2. Press the **Power** button.
3. Select cycle using the **Cycle Selector**.
4. After cycle selection, set each option.
 -  See the "Cycle Chart" on page 37 for available option settings with each cycle.
5. You can then store the selected cycle and options by pressing and holding the **My Cycle** button for longer than 3 seconds in My Cycle mode. The cycle and options you select will be displayed the next time you choose the My Cycle function.
 -  You can change the My Cycle settings by repeating the same process above. The last used setting will be displayed the next time you choose the My Cycle function.
 -  If you press My Cycle and release it within 3 seconds, the previously saved course and options appear. If you press and hold My Cycle for 3 second or longer, the currently set course and options are saved and the LED blinks for 3 seconds.

washing a load of laundry

Eco Bubble

Eco Bubble allows detergent to distribute evenly and penetrate fabrics faster and deeper.

Course	Bubble function	Canceling the bubble function
Sanitize, Towels, Delicates, Cotton, Synthetics, Bedding, Quick Wash, Water Saving	Available	Available
Super Eco Wash, Sport Wear, Baby Care, Wool		Not available

- A different bubble function may be applied depending the course.



Eco Bubble selection is default. Press it once to deselect bubble option, press it again to select bubble option.

1. Open the door, place the laundry inside the wash tub and close the door.
 2. Press the **Power** button.
 3. Select a function.
 4. Place the appropriate amount of detergent and fabric softener into the corresponding compartments depending on the amount of laundry and close the detergent drawer.
 - Add the appropriate amount of detergent into the detergent compartment ①, and add the fabric softener to softener compartment ② just under the fiber softener base line (MAX) of "A"
 - When the Prewash course is selected, add detergent into the prewash compartment ③ as well.
 - To use liquid detergent, leave the liquid detergent box in the drawer (refer to "Liquid Detergent" section on page 30).
- Do not add powdered detergent into the liquid detergent box.
5. Press the Start/Pause button.
 - Press the **Start/Pause** button to start the wash.
 - The amount of the laundry is automatically detected and the laundry is washed.
 - Once a washing machine operation begins, you cannot add or select the bubble function.
- Enough bubbles are generated with the specified amount of detergent.
 - Please clean the Debris filter frequently. Periodic cleaning helps generate sufficient bubbles.
 - Depending on the detergent and the laundry, the bubbles may be absorbed and seem like a Small Load quantity.
 - Although bubbles are generated once the wash begins, it may take several minutes for users to see them.

Washing clothes using the cycle selector

Your new washing machine makes washing clothes easy, using Samsung's "Fuzzy Control" automatic control system. When you select a wash program, the machine will set the correct temperature, washing time, and washing speed.

1. Turn on your sink's water tap.
2. Press the **Power** button.
3. Open the door.
4. Load the articles of clothing one at a time loosely into the drum, without overfilling it.
5. Close the door.
6. Add detergent, softener, and pre-wash detergent (if necessary) into the appropriate compartments.

 Pre-wash is only available when selecting the Cotton, Synthetics and Baby Care cycles. It is only necessary if your clothing is heavily soiled.

7. Use the Cycle Selector to select the appropriate cycle according to the type of material: Cotton, Synthetics, Bedding, Quick Wash, Super Eco Wash, Sports Wear, Baby Care and Wool. The relevant indicators will illuminate on the control panel.
8. At this time, you can control the wash temperature, the number of rinse cycles, the spinning speed, and the delay time by pressing the appropriate option button.
9. Press the Start/Pause button on the Cycle Selector and the wash will begin. The process indicator will light up and the remaining time for the cycle will appear in the display.

Pause Option

1. Within 5 minutes of starting a wash, it is possible to add/remove laundry items to the wash.
2. Press the Start/Pause button to unlock the door.
3. The door cannot be opened when the water is too HOT or the water level is too HIGH.
4. After closing the door, press the Start/Pause button to restart the wash.

When the cycle is finished:

After the total cycle has finished, the power will turn off automatically.

1. Open the door.
2. Remove laundry.

washing a load of laundry

Washing clothes manually

You can wash clothes manually without using the Cycle Selector.

1. Turn the water supply on.
2. Press the **Power** button on the washing machine.
3. Open the door.
4. Load the articles loosely into the drum one at a time, without overfilling it.
5. Close the door.
6. Add detergent and, if necessary, softener or prewash detergent, into the appropriate compartments.
7. Press the **Temp.** button to select the temperature. (Cold water, 30 °C, 40 °C, 60 °C, 95 °C)
8. Press the **Rinse** button to select the required number of rinse cycles.
The maximum number of rinse cycles is five.
The wash duration is increased accordingly.
9. Press the **Spin** button to select the spin speed. (☒ : No Spin)
10. Press the **Delay End** button repeatedly to cycle through the available Delay End options (from 3 hour to 19 hours in one hour increments). The hour displayed indicates the time at which the wash will be finished.
11. Press the **Start/Pause** button and the machine will begin the cycle.

LAUNDRY GUIDELINES

Follow these simple guidelines for the cleanest laundry and the most efficient wash.

-  Always check the Care label on clothing before washing.

Sort and wash your laundry according to the following criteria:

- Care Label: Sort laundry into cottons, mixed fibres, synthetics, silks, wools and rayons.
- Colour: Divide whites and colours. Wash new colour items separately.
- Size: Placing items of different sizes in the same load will improve the wash action.
- Sensitivity: Wash delicate items separately, using the Delicate wash cycle for pure, new woollen items, curtains and silk articles. Check the labels on the items you are washing or refer to the fabric care chart in the appendix.

Emptying pockets

Before each wash, empty all the pockets of your laundry. Small Load, irregularly shaped hard objects, such as coins, knives, pins, and paperclips could damage your washing machine. Do not wash clothing with large buckles, buttons, or other heavy metal objects. Metal on clothing may damage your clothing as well as the tub. Turn clothing with buttons and embroidered clothes inside out before washing them. If zips of pants and jackets are open while washing, the spin basket may be damaged. Zips should be closed and fixed with a string before washing.

Clothing with long strings may become entangled with other clothes damaging them. Be sure to fix the strings before starting the wash.

Prewashing cotton

Your new washing machine, combined with modern detergents, will give perfect washing results, thus saving energy, time, water and detergent. However, if your cotton is particularly dirty, prewash with a protein-based detergent.

Determining the load capacity

Do not overload the washing machine or your laundry may not wash properly. Use the chart below to determine the load capacity for the type of laundry you are washing.

Fabric Type	Load Capacity
Model	WF431
Sanitize	6,0 kg
Towels	6,0 kg
Delicates	3,0 kg
Wool	3,0 kg
Baby Care	6,0 kg
Sports Wear	4,0 kg
Super Eco Wash	6,0 kg
Cotton	14,0 kg
Synthetics	6,0 kg
Bedding	6,0 kg
Quick Wash	3,0 kg
Water Saving	10,0 kg

-  • When the laundry is unbalanced ("UE" lights up on the display), redistribute the load. If the laundry is unbalanced, the spin efficiency may be degraded.
- When washing Bedding or Duvet cover, the wash time may be lengthened or the spin efficiency may be degraded.

 **Make sure to insert brassieres (water washable) into a laundry net (to be purchased additionally).**

- The metal parts of the brassieres may break through the material and damage the laundry. Therefore make sure to place them inside a fine laundry net.
- Small Load, light clothing such as socks, gloves, stockings and handkerchiefs may become caught around the door. Place them inside a fine laundry net.



Do not wash the laundry net by itself without other laundry. This may cause abnormal vibrations that could move the washing machine and cause an accident resulting in injury.

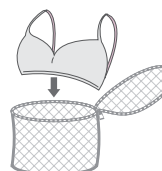



washing a load of laundry

DETERGENT AND ADDITIVES INFORMATION

Which detergent to use

The type of detergent you should use is based on the type of fabric (cotton, synthetic, delicate items, wool), colour, wash temperature, and degree of soiling. Always use "low suds" laundry detergent, which is designed for automatic washing machines.

Follow the detergent manufacturer's recommendations based on the weight of the laundry, the degree of soiling, and the hardness of the water in your area. If you do not know how hard your water is, enquire at your local water authority.



-  Do not use detergent that has hardened or solidified as the detergent may remain in the rinse cycle. It may cause your washing machine to not rinse properly or result in the overflow becoming blocked.
-  **Please note the following when using the Wool course.**
 - Use a neutral liquid detergent for wool only.
 - When using a powder detergent, it may remain on the laundry and cause damage to the material (wool).

Detergent drawer

Your washing machine has separate compartments for dispensing detergent and fabric softener. Add all laundry additives to the correct compartment before starting your washing machine.

-  Do not open the detergent drawer while your washing machine is running or you might be exposed to hot water or steam.

1. Pull out the detergent drawer on the left side of the control panel.
2. Add the recommended amount of laundry detergent directly into the detergent compartment ① before starting your washing machine.
3. Add the recommended amount of fabric softener into the softener compartment ② if required. DO NOT exceed the MAX FILL (A) line.
4. When using the Prewash option, add the recommended amount of laundry detergent into the prewash compartment ③.

-  When washing large items do NOT use the following detergent types.
 - Tablet and capsule type detergents
 - Detergents using a ball and net
-  Concentrated or thick fabric softener and conditioner must be diluted with a little water before being poured into the dispenser (prevents the overflow from becoming blocked).

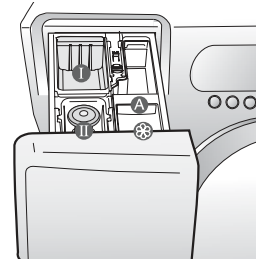

cleaning and maintaining your washing machine

CLEANING THE EXTERIOR

Turn off the water faucets after finishing the day's washing.

This will shut off the water supply to your Washer and prevent the unlikely possibility of damage from escaping water. Leave the door open to allow the inside of your Washer to dry out.

Use a soft cloth to wipe up all detergent, bleach or other spills as they occur.

Clean the following as recommended:

Control Panel – Clean with a soft, damp cloth. Do not use abrasive powders or cleaning pads. Do not spray cleaners directly on the panel.

Cabinet – Clean with soap and water.

CLEANING THE INTERIOR

Clean the interior of your Washer periodically to remove any dirt, soil, odor, mold, mildew, or bacterial residue that may remain in your Washer as a result of washing clothes.

Failure to follow these instructions may result in unpleasant conditions, including odors and/or permanent stains on your Washer or laundry.

Hard water deposits may be removed, if needed. Use a cleaner labeled "Washer safe".

- After washing a lot of towels or mats, foreign material such as lint may remain on the door glass. Remove any foreign material such as lint periodically so that it does not accumulate.

CLEANING THE DISPENSERS

The automatic dispenser may need to be cleaned periodically due to laundry additive buildup.

- Pull out the detergent liquid from detergent compartment.
- Remove the siphon cap from the fabric softener and bleach compartments.
- Wash all of the parts under running water.
- Clean the dispenser recess with a soft brush.
- Reinsert the siphon cap and push it firmly into place.
- Push the dispenser back into place.
- Run a Rinse+Spin cycle without any load in your washer.

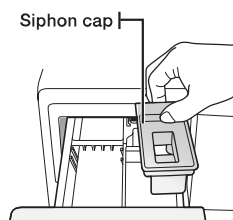
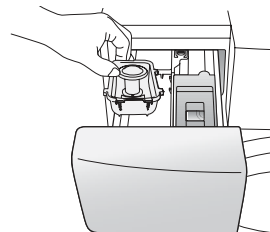

cleaning and maintaining your washing machine

STORING YOUR WASHER

Washers can be damaged if water is not removed from hoses and internal components before storage. Prepare your Washer for storage as follows:

- Select the Quick Wash cycle and add bleach to the automatic dispenser. Run your Washer through the cycle without a load.
- Turn the water faucets off and disconnect the inlet hoses.
- Unplug your Washer from the electrical outlet and leave your Washer door open to let air circulate inside the tumbler.
- If your Washer has been stored in below-freezing temperatures, allow time for any leftover water in your Washer to thaw out before use.

CLEANING THE DEBRIS FILTER

We recommend cleaning the debris filter when water does not drain well or the "ND" error message is displayed.

1. Open the filter cover by pressing and pulling the handle of the filter cover with your finger.



2. Unscrew the drain cap by turning it counterclockwise.
3. Hold the cap on the end of the drain tube and slowly pull it out about 6 inches (15 cm) and drain off all the water.

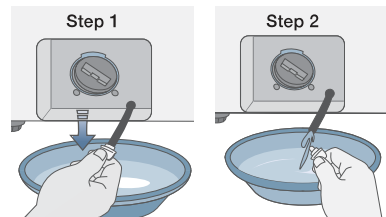

4. Remove the debris filter cap.



5. Wash any dirt or other material from the debris filter. Make sure the drain pump propeller behind the debris filter is not blocked.
6. Replace the debris filter cap.
7. Replace the filter cover.

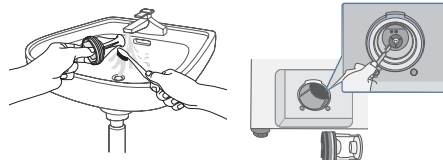

CLEANING THE DOOR SEAL/BELLOW

1. Open the washer door and remove any clothing or items from the washer.
2. Inspect the gray colored seal/bellow between the door opening and the basket for stained areas. Pull back the seal/bellow to inspect all areas under the seal/bellow and to check for foreign objects.

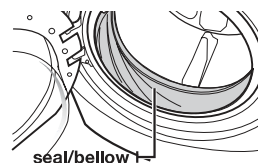

3. If stained areas are found, wipe down these areas of the seal/bellow, using the procedure that follows.
 - a) Mix a dilute solution, using $\frac{3}{4}$ cup (177 mL) of liquid chlorine bleach, and 1 gal. (3,8 L) of warm tap water.
 - b) Wipe the seal/bellow area with the dilute solution, using a damp cloth.
 - c) Let stand 5 minutes.
 - d) Wipe down area thoroughly with a dry cloth and let the washer interior air dry with door open.



IMPORTANT:

- Wear rubber gloves when cleaning for prolonged periods.
- Refer to the bleach manufacturer's instructions for proper use.

CLEANING THE DOOR GLASS

1. Open the washer door and remove any clothing or items from the washer.
2. Clean the door glass after finishing the day's washing.

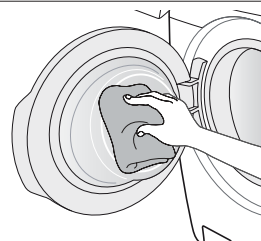

- After washing a lot of towels or mats, foreign material such as lint may remain on the door glass. Remove any foreign material such as lint periodically so that it does not accumulate.

PRESERVING THE TOP COVER AND THE FRONT FRAME

Do not place any heavy or sharp objects or a detergent box on the washing machine. Keep them on the purchased pedestal or in a separate storage box. This may scratch or damage the top cover of the washing machine.



- Since the entire washing machine has a high-gloss finish, the surface can be scratched or damaged. Therefore, avoid scratching or damaging the surface when using the washing machine.

troubleshooting and information codes

CHECK THESE POINTS IF YOUR WASHING MACHINE...

PROBLEM	SOLUTION
Will not start..	<ul style="list-style-type: none"> • Make sure the door is firmly closed. • Make sure your Washer is plugged in. • Make sure the water source faucets are open. • Make sure to press the Start/Pause Button to start your Washer. • Make sure the Child Lock is not activated; see page 24. • Before your Washer starts to fill, it will make a series of clicking noises to check the door lock and do a quick drain. • Check the fuse or reset the circuit breaker
Has no water or not enough water..	<ul style="list-style-type: none"> • Turn both faucets on fully. • Make sure the door is tightly closed. • Straighten the water inlet hoses. • Disconnect hoses and clean screens. Hose filter screens may be clogged. • Open and close the door, then press the Start/Pause Button.
Has detergent remains in the automatic dispenser after the wash cycle is complete.	<ul style="list-style-type: none"> • Make sure your Washer is running with sufficient water pressure. • Make sure the Detergent Selector dial is in the upper position when using granular detergent.
Vibrates or is too noisy.	<ul style="list-style-type: none"> • Make sure your Washer is set on a level surface. If the surface is not level, adjust your Washer feet to level the appliance. • Make sure that the shipping bolts are removed. • Make sure your Washer is not touching any other object. • Make sure the laundry load is balanced.
Stops	<ul style="list-style-type: none"> • Plug the power cord into a live electrical outlet. • Check the fuse or reset the circuit breaker. • Close the door and press the Start/Pause Button to start your Washer. For your safety, your Washer will not tumble or spin unless the door is closed. • Before your Washer starts to fill, it will make a series of clicking noises to check the door lock and do a quick drain. • There may be a pause or soak period in the cycle. Wait briefly and it may start. • Check the screens on the inlet hoses at the faucets for obstructions. Clean the screens periodically.

PROBLEM	SOLUTION
Fills with the wrong temperature water.	<ul style="list-style-type: none"> • Turn both faucets on fully. • Make sure the temperature selection is correct. • Make sure the hoses are connected to the correct faucets. Flush water lines. • Check the water heater. It should be set to deliver a minimum 120° F (49° C) hot water at the tap. Also check the water heater capacity and recovery rate. • Disconnect the hoses and clean the screens. The hose filter screens may be plugged. • As your Washer is filling, the water temperature may change as the automatic temperature control feature checks incoming water temperature. This is normal. • While your Washer is filling, you may notice just hot and/or just cold water going through the dispenser when cold or warm wash temperatures are selected. This is a normal function of the automatic temperature control feature as your Washer determines the temperature of the water.
Door locked or will not open.	<ul style="list-style-type: none"> • Press the Start/Pause Button to stop your Washer. • Your Washer door will remain locked during the heating portion of the Sanitize Cycle • It may take a few moments for the door lock mechanism to disengage.
Does not drain and/or spin.	<ul style="list-style-type: none"> • Check the fuse or reset the circuit breaker. • Straighten the drain hoses. Eliminate kinked hoses. If there is a drain restriction, call for service. • Close the door and press the Start/Pause Button. For your safety, your Washer will not tumble or spin unless the door is closed. • Make sure the debris filter is not clogged.
Load is too wet at the end of the cycle.	<ul style="list-style-type: none"> • Use the High or Extra High spin speed. • Use high efficiency detergent to reduce over-sudsing. • Load is too Small Load, Very Small Load loads (one or two items) may become unbalanced and not spin out completely.
Leaks water.	<ul style="list-style-type: none"> • Make sure the door is firmly closed. • Make sure all hose connections are tight. • Make sure the end of the drain hose is correctly inserted and secured to the drainage system. • Avoid overloading. • Use high efficiency detergent to prevent over-sudsing.
Has excessive suds.	<ul style="list-style-type: none"> • Use high efficiency detergent to prevent over-sudsing. • Reduce the detergent amount for soft water, Small Load or lightly soiled loads. • Non-HE detergent is NOT recommended.

If the problem persists, contact your local Samsung Customer Service.

troubleshooting and information codes

INFORMATION CODES

If your washing machine malfunctions, you may see an information code on the display. If this happens, please check the table below and try the suggested solution before calling Customer Service.

CODE SYMBOL	SOLUTION
dE	<ul style="list-style-type: none">• Make sure the door is firmly closed.• Make sure that laundry is not caught in the door.
4E	<ul style="list-style-type: none">• Make sure the source water tap is turned on.• Check the water pressure.
5E	<ul style="list-style-type: none">• Clean the debris filter.• Make sure the drainage hose is installed correctly.
UE	<ul style="list-style-type: none">• The laundry load is unbalanced. Redistribute the load. If only one item of clothing needs washing, such as a bathrobe or pair of jeans, the final spin result might be unsatisfactory and an "UE" error message will be shown in the display window.
cE/3E	<ul style="list-style-type: none">• Call the after-sales service.
Hot	<ul style="list-style-type: none">• It appears when the internal temperature of the drum is high. The fan will automatically function, so just wait until "Hot" indication disappeared.

For any codes not listed above, or if the suggested solution doesn't fix the problem, call your Samsung Service Centre or local Samsung dealer.

cycle chart

CYCLE CHART

(● default option, ● user option)

PROGRAM	Functions														
	Temp (°C)					Rinse					Spin Speed(MAX) rpm				
	Cold	30	40	60	95	1	2	3	4	5	No Spin	400	800	1000	1200
Sanitize	-	-	-	-	●	-	●	●	●	●	●	●	●	●	●
Towels	●	●	●	●	●	●	●	●	●	●	●	●	●	-	-
Delicates	●	●	●	-	-	●	●	●	●	●	●	●	●	-	-
Wool	●	●	●	-	-	●	●	●	-	-	●	●	●	●	-
Baby Care	●	●	●	●	●	-	●	●	●	●	●	●	●	●	●
Sports Wear	●	●	●	●	-	●	●	●	●	●	●	●	●	●	●
Super Eco Wash	●	●	●	-	-	●	●	●	●	●	●	●	●	●	●
Cotton	●	●	●	●	●	●	●	●	●	●	●	●	●	●	●
Synthetics	●	●	●	●	-	●	●	●	●	●	●	●	●	●	●
Bedding	●	●	●	●	-	●	●	●	●	●	●	●	●	●	-
Quick Wash	●	●	●	-	-	●	●	●	●	●	●	●	●	●	●
Water Saving	●	●	●	●	-	●	●	-	-	-	●	●	●	●	●
Rinse + Spin	-	-	-	-	-	●	●	●	●	●	●	●	●	●	●
Eco Drum Clean	-	-	-	●	-	-	●	-	-	-	-	●	-	-	-

05 CYCLE CHART

























PROGRAM	Pre Wash	Intensive Wash	Eco Bubble	Easy Iron	Delay End
Sanitize	●	●	●	●	●
Towels	●	●	●	●	●
Delicates	-	-	●	-	●
Wool	-	-	●	-	●
Baby Care	●	●	●	●	●
Sports Wear	●	●	●	●	●
Super Eco Wash	●	●	●	●	●
Cotton	●	●	●	●	●
Synthetics	●	●	●	●	●
Bedding	-	●	●	●	●
Quick Wash	-	-	●	-	●
Water Saving	●	●	●	●	●
Rinse + Spin	-	-	-	-	●
Eco Drum Clean	-	-	-	-	●

1. A cycle with a prewash takes approx. 15 minutes longer.
2. The cycle duration data has been measured under the conditions specified in Standard IEC 60456 / EN 60456. Please run Calibration Mode after the installation (see page 20).
3. Course time in individual homes may differ from the values given in the table due to variations in the pressure and temperature of the water supply, the load and the type of laundry.

appendix

FABRIC CARE CHART

The following symbols provide garment care directions. The care labels include four symbols in this order: washing, bleaching, drying and ironing (and dry cleaning when necessary). The use of symbols ensures consistency among garment manufacturers of domestic and imported items. Follow the care label directions to maximize garment life and reduce laundry problems.

	Resistant material		Can be ironed at 100 °C max
	Delicate fabric		Do not iron
	Item may be washed at 95 °C		Can be dry cleaned using any solvent
	Item may be washed at 60 °C		Dry clean with perchloride, lighter fuel, pure alcohol or R113 only
	Item may be washed at 40 °C		Dry clean with aviation fuel, pure alcohol or R113 only
	Item may be washed at 30 °C		Do not dry clean
	Item may be hand washed		Dry flat
	Dry clean only		Can be hung to dry
	Can be bleached in cold water		Dry on clothes hanger
	Do not bleach		Tumble dry, normal heat
	Can be ironed at 200 °C max		Tumble dry, reduced heat
	Can be ironed at 150 °C max		Do not tumble dry

PROTECTING THE ENVIRONMENT

- This appliance is manufactured from recyclable materials. If you decide to dispose of this appliance, please observe local waste disposal regulations. Cut off the power cord so that the appliance cannot be connected to a power source. Remove the door so that animals and Small Load children cannot get trapped inside the appliance.
- Do not exceed the detergent quantities recommended in the detergent manufactures' instructions.
- Use stain removal products and bleaches before the wash cycle only when strictly necessary.
- Save water and electricity by only washing full loads (the exact amount depends upon the program used).

DECLARATION OF CONFORMITY

This appliance complies with European safety standards, EC directive 93/68 and EN Standard 60335.

SHEET OF HOUSEHOLD WASHING MACHINES

According to Regulation (EU) No. 1061/2010

Samsung			
Model Name		WF431ABP	
Capacity	kg	14	
Energy Efficiency			
A+++ (highest efficiency) to D (least efficient)		A++	
Energy Consumption			
Annual Energy Consumption (AE_C)	kWh/yr	360	
Energy consumption (E_t.60) Cotton 60 °C at full load	kWh	2.03	
Energy consumption (E_t.60.1/2) Cotton 60 °C with partial load	kWh	1.55	
Energy consumption (E_t.40.1/2) Cotton 40 °C with partial load	kWh	1.06	
Weighted power off-mode (P_o)	W	0.45	
Weighted Power in left-on mode (P_l)	W	5	
Annual water consumption (AW_c)	L/yr	20020	
Spin efficiency class¹⁾			
A (most efficient) to G (least efficient)		B	
Maximum Spin Speed	rpm	1200	
Residual moisture	%	56	
Programs to which the information on the label and the sheet relate		Cotton 60 °C and 40 °C + Intensive + Eco Bubble ²⁾	
Program duration of the standard program			
Cotton 60 °C at full load	min	216	
Cotton 60 °C for partial load	min	196	
Cotton 40 °C with partial load	min	166	
Weighted time in left-on mode	min	2	
Airborne noise emissions			
Wash	dB (A) re 1 pW	60	
Spin	dB (A) re 1 pW	70	
Dimensions			
Unit dimensions	Height	cm	99
	Width	cm	69
	Depth ³⁾	cm	82
Net weight	kg	99	
Gross weight	kg	102	
Package weight	kg	3	
Water Pressure	kPa	137-800	
Electrical connection			
Voltage	V	220-240	
Power consumption	W	2000-2400	
Frequency	Hz	50	
Supplier name	Samsung Electronics Co., Ltd.		

-  1) Spin extraction is very important when you use a clothes dryer to dry your clothes. The energy for drying costs much higher than the energy for washing. Wasing with the high spin saves more energy in drying your clothes in a clothes dryer.
- 2) The 'standard cotton 60 °C program' and 'standard cotton 40 °C program', which can be selected by adding the Intensive option to the cotton 60 °C and cotton 40 °C program, are the most efficient (concerning water and energy consumption) for this type of laundry. The Eco Bubble option always turns on in the 'cotton 60 °C program' and 'cotton 40 °C program'. Please run Calibration Mode after the installation (see page 20). In these programs the actual water temperature may differ from the declared temperature.
- 3) Distance to the wall from the unit is not included in the depth dimension.

WARRANTY



UNITED KINGDOM



IRELAND

This Samsung product is warranted against defective materials for the period of twenty four (24) months from the original date of purchase. Labour is not provided by Samsung. In the event that warranty service is required, you should contact the retailer from whom it was purchased. Warranty Service outside of UK / Eire must be organised with your retailer.

In case of difficulty, details of our Authorised Service Centres are available from:

Samsung Electronics U.K. Ltd.
Customer Care Centre PO Box 479 GATESHEAD NE9 9BJ United Kingdom
www.samsung.com

Tel: 0330 SAMSUNG (7267864) Fax : 0330 7260001 (United Kingdom)
Tel: 0818 717 100, Fax: +44 117 915 6736 (Republic of Ireland)

■ WARRANTY CONDITIONS

1. The warranty is only valid if, when warranty service is required, the warranty card is fully and properly completed and is presented with the original invoice or sales slip or confirmation, and the serial number on the product has not been defaced.
2. Samsung's obligations are limited to the replacement of the defective part or, at Samsung's discretion, replacement of the machine. All labour costs will depend on the contract between purchaser and retailer and will not be covered by Samsung.
3. Warranty repairs must be carried out by Authorised Samsung Dealers or Authorised Service Centres. No re-imbusement will be made for repairs carried out by non Samsung Dealers and, any such repair work and damage to the products caused by such repair work will not be covered by this warranty.
4. This product is not considered to be defective in materials nor workmanship by reason that it requires adaptation in order to conform to national or local technical or safety standards in force in any Country other than the one for which the product was originally designed and manufactured. This warranty will not cover, and no re-imbusement will be made for such adaptation nor any damage which may result.
5. This warranty covers none of the following:
 - a) Periodic check ups, maintenance and repair or replacement of parts due to normal wear and tear.
 - b) Cost relating to transport, removal or installation of the product.
 - c) Misuse, including the failure to use this product for its normal purposes or incorrect installation.
 - d) Damage caused by Lightning, Water, Fire, Acts of God, War, Public Disturbances, incorrect mains voltage, improper ventilation or any other cause beyond the control of Samsung.
6. This warranty is valid for any person who legally acquired possession of the product during the warranty period.
7. The consumers statutory rights in any applicable national legislation whether against the retailer arising from the purchase contract or otherwise are not affected by this warranty. Unless there is national legislation to the contrary, the rights under this warranty are the consumers sole rights and Samsung, its subsidiaries and distributors shall not be liable for indirect or consequential loss or any damage to equipment or material, Items or property.

SAMSUNG ELECTRONICS (U.K.) LTD.

SAMSUNG

memo

memo

memo



QUESTIONS OR COMMENTS?

Country	CALL	OR VISIT US ONLINE AT
U.K	0330 SAMSUNG (7267864)	www.samsung.com

Code No. DC68-03074F_EN